

Braking Devices
VB 230/400-6/25/30LT
Assembly- and Commissioning Instructions

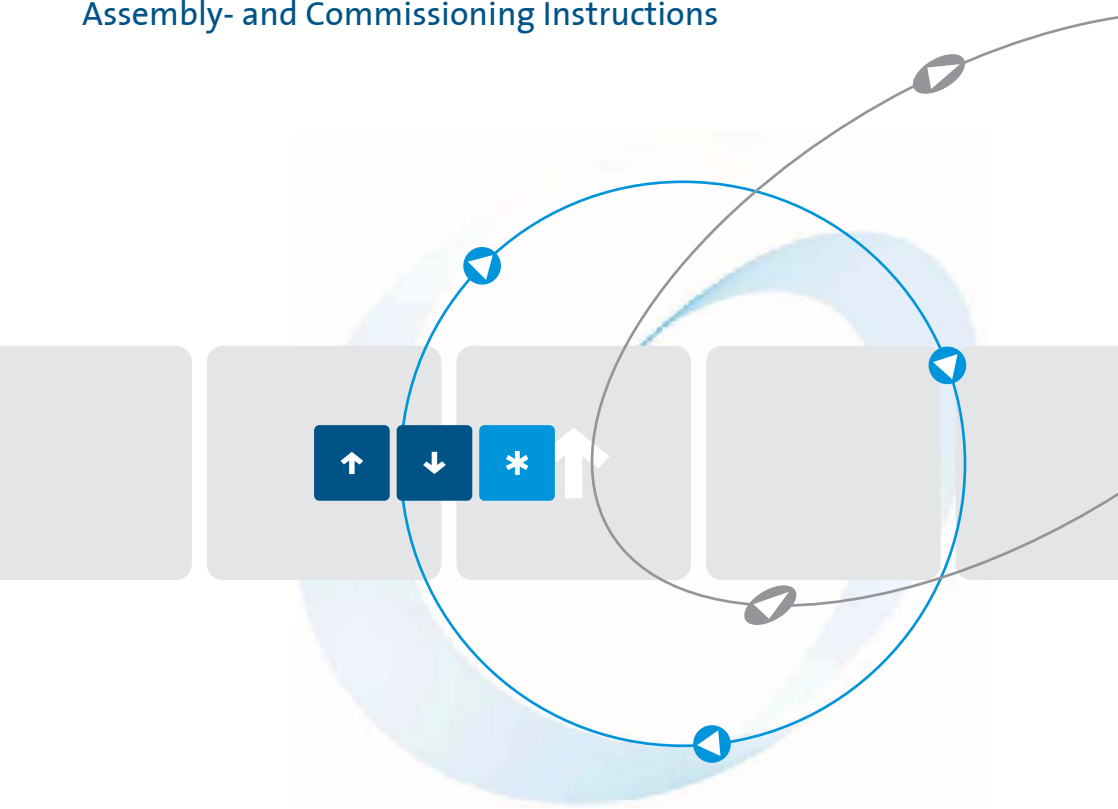

as per 06/18 1B200.10001

Table of Contents	Page
1. Safety notes	3
2. Conformity	3
3. General description	4
4. Usage to the intended purpose	4
5. EC Declaration of Contormity	5
6. Block diagram	6
7. Functional description (see connection diagram)	6
7.1 LED indicators	7
8. Control inputs and outputs	8
8.1 Control input	8
8.2 Control outputs	9
9. Potentiometers	10
10. Technical data	11
10.1 Environmental conditions	11
11. Commissioning	12
11.1 Mounting instructions	12
11.2 Connection	12
11.3 Parameter settings	13
11.4 Possible fault indications during commissioning	14
12. Dimensioning rules	16
12.1 Dimensioning of braking contactors	16
12.2 Dimensioning of pre-fuses	16
12.3 Permissible braking frequency	18
13. Dimensions	20
14. Typical connections	21
14.1 Connection diagram	21

These commissioning instructions were prepared with great care. Nevertheless, PETER electronic GmbH & Co. KG does not assume liability for damage resulting from mistakes possibly contained in this manual. Technical changes that serve to improve the product are subject to change without notice.



Disposal Instructions

Equipment containing electrical components may not be disposed of together with domestic waste. It must be collected separately as electrical and electronic waste according to local and currently valid legislation.

Notes and symbols used in these instructions

Note: Notes explain the advantages of certain adjustments or settings and help you to make use of the device in the best possible way.



Warning notices: Read them carefully and follow them strictly!

Warning notices are indicated in order to protect you against danger or to help you to prevent the device from being damaged.



Caution: Danger to life through electric shock!

When you see this sign, always make sure that the device is de-energized and secured against unintentional energizing.

1. Safety notes



The described devices are electrical equipment for use in industrial electrical power installations. An impermissible removal of the covers during operation can cause serious damage to your health, since these devices contain live parts with high voltages.

Adjustment work may only be performed by trained staff observing the safety regulations. Assembly and mounting work may only be carried out with the equipment deenergized.

Make sure that all drive components are properly earthed.

Please read these commissioning instructions carefully before putting the device into operation.

Besides, the user must ensure that the devices and associated components are fitted and connected in accordance with the applicable local, legal and technical regulations. The VDE-regulations VDE 0100, VDE 0110 (EN 60664), VDE 0160 (EN 50178) , VDE 0113 (EN 60204, EN 61310), VDE 0660 (EN 50274) plus the appropriate regulations of the TÜV (Technical Control Association) and the trade associations apply in Germany.

The user must ensure that the drive turns into a safe operating state following a device failure, in the event of maloperation, or if the control unit has failed etc..

Caution: Even if the motor is at rest, it is **not** physically separated from the mains.

2. Conformity

In industrial linguistic usage the electronic brakes of the type series VersBrake...-LT are called „devices“, however, in the sense of the „law on the safety of equipment“, the „EMC-law“ or the „EC machinery directive“ they are not devices or machines ready for use or connection but they are components. It is only possible to define their final function, when these components are integrated into the design and construction of the user.

To be able to use the devices to their intended purpose, it requires power supply networks according to DIN EN 50160 (IEC38).

The user takes the responsibility that the user's design and construction comply with the applicable legal provision.

The commissioning is strictly forbidden as long as the conformity of the final product with the guidelines 2006/42/EC (Machinery directive) and 2006/95/EC (Low voltage directive) is not proved.

3. General description

The electronic braking devices of the VersiBrake LT-type enable non-wearing braking of three-phase and single-phase asynchronous motors. The braking devices are used for drives that, due to safety and functional reasons, have to be reliably slowed down. Braking is initiated when the connected and normally closed contact of the motor contactor is reclosed. After a time lapse adjusted with the potentiometer „t“, the braking current adjusted with „I“ is switched off.

The operational status and any possible faults are indicated via LEDs and a flashing mode.

Special features

- controlled by microcontroller
- wear-resistant and maintenance-free
- for three-phase asynchronous motors
- for mono-phase motors
- retrofitting into existing plants possible
- integrated braking contactor
- automatic remanence time optimization
- integrated overload monitoring
- braking current contro
- Braking interrupt possible
- Restart possible 1,2s after braking interrupt
- Wide adjustment range of the braking time (0...30s)
- Suitable as a replacement for braking devices of the types BR and BR-L

4. Usage to the intended purpose

The devices of the VersiBrake...-LT-series are electrical equipment that is used in industrial electrical power installations. They are designed for application in machines, in order to slow down rotating masses on drives with three-phase a.c. motors.

Typical applications

- sawing machines
 - centrifuges
 - wood working machines
 - conveying systems
 - textile machines
-

5. EC Declaration of Contormity

EC Declaration of Conformity 

The manufacturer / company placing the product on the market
(authorized representatives of the manufacturer / companies placing the product on the market
that are established within the Community)

Name / Address: PETER electronic GmbH & Co. KG
Bruckäcker 9
92348 Berg

hereby declares that the following product (device, component, unit) in the version as supplied

Product designation:	Braking device
Series / type designation:	VB 230/400-6/25/30LT
Article number:	2B2...
Year of manufacture:	2007

complies with the provisions of the following EU-directives:

- | | |
|-------------------|---|
| 2014/30/EU | Electromagnetic compatibility |
| 2014/35/EU | Electrical equipment designed for use within certain voltage limits |
| 2011/65/EU | The restriction of the use of certain hazardous substances in electrical and electronic equipment |

The following harmonized standards have been applied:

- | | |
|--------------------------------|--|
| EN 60947-1:2007+A1:2012 | Low-voltage switchgear and controlgear General rules |
| EN 60947-4-2:2012 | Low-voltage switchgear and controlgear
Contactors and motor-starters - AC semiconductor motor
controllers and starters |

This EC Declaration of Conformity is no longer valid, if the product is modified or changed
without our agreement.

This declaration is issued under the sole responsibility of the signatory.

Berg, 15.04.2016 Dr. Thomas Stiller, Managing director
(place, date) (signatory and function of the signatory)

(signature)

6. Block diagram

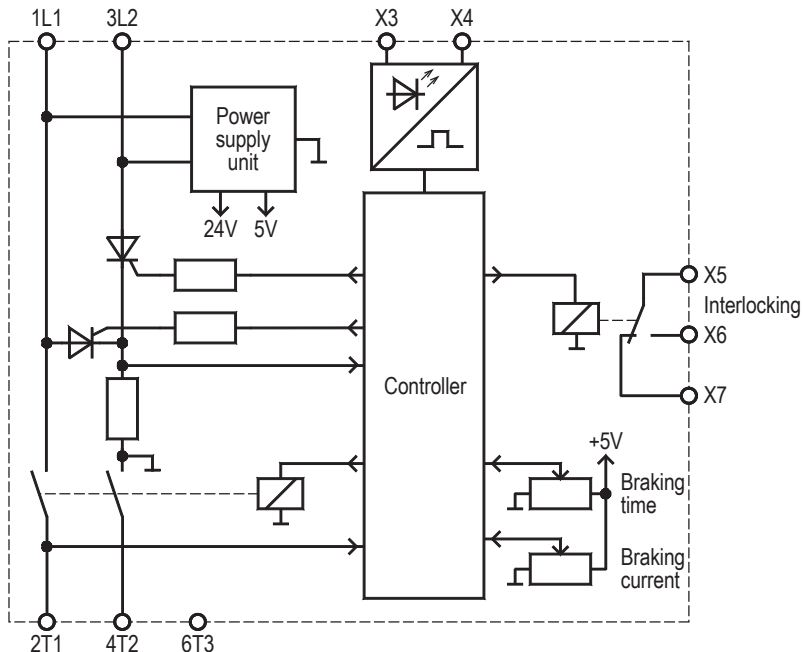

7. Functional description (see connection diagram)

After the operating voltage on 1L1 and 3L2 has been switched on, the main contactor interlock X5, X6, the fault signaling contact closes. The motor can be started.

A starting logic makes sure that, when switching the plant on with the master switch while the motor is still switched off, braking is not initiated.

The fully automatic run of the braking interval starts when the normally closed contact (connected to the terminals X3, X4) of the motor contactor is reclosed. During braking, the main contactor is interlocked via the contact X5, X6. After a delay time which, dependent on the amount of the remanent voltage of the motor, optimizes itself, the integrated braking relay pulls in. After the contact bounce time has been waited out, a controlled d.c. current is fed into the motor winding. The magnetic field resulting from this has a braking effect on the still rotating rotor. The d.c. current is generated by a thyristor phase control. Special suppressor circuits protect the power semiconductors against overvoltage. With the potentiometer „I“, the braking current (and thus the braking torque) can be adjusted within a range of 10 ... 100% of the rated device current. The length of time the braking current is to flow can be adjusted with the potentiometer „t“ within a range of 0...30s/60s. To protect the braking device against overloading in the case of braking times exceeding 20s, the adjustable maximum braking current (rated device current) decreases.

For the braking currents applicable to the respective braking times please refer to the table under point 7. By using an integrated monitoring function, the device protects itself against overloading caused by a too high braking frequency. For commissioning or setting-up purposes, 5 braking operations in direct succession are allowed. If exceeding of the permissible maximum braking frequency is detected, the motor will be interlocked against switch-on (In the case of the special version SO1, overloading is only indicated. The motor is not interlocked against switch-on). This interlock can be reset only by switching off the operating voltage.

Faults occurring during braking are indicated via a flashing mode.

If the motor is to be restarted during a braking operation, it is first of all necessary to stop the braking operation. For this, the contact X3-X4 is to be opened for the least 150ms. When the contact X3-X4 is reclosed, the motor can be restarted after 1200ms.

Note: If the braking time at rated device current is too short, due to the fact that the centrifugal masses to be slowed down are too large, a device featuring a higher rated current has to be used.

7.1 LED indicators

LED – ready - Illuminated - Flashing 2x ^a - Flashing 3x ^a - Flashing 4x ^a	Operational status - Mains voltage is applied, braking device is ready - Adjusted braking current was not reached - Braking frequency too high - Program- or controller-error
---	--

a. ... repeated with a short pause

LED – I - Illuminated	Operational status - Braking current is flowing
---------------------------------	---

8. Control inputs and outputs

8.1 Control input

Control terminals	Designation	Description
X3, X4	Starting contact	Connection of a normally closed contact of the motor contactor.

Braking interrupt:

With the input X3, X4, a braking interrupt can be effected. For this purpose, another normally closed contact has to be connected in series before the normally closed contact of the motor contactor. Opening of this contact for at least 150ms will cause a braking interrupt.

After closing of this contact - however after 1200ms at the earliest - the motor can be restarted.



Caution: Danger to life through electric shock!

The terminals X3, X4 carry mains potential; when laying the connecting lines, be sure to provide protection against accidental contact.

8.2 Control outputs

Control terminals	Designation	Description
X5, X6, X7	Interlock (potential-free changeover contact, common contact on X5)	<p>During braking, the contact between X5 and X6 is open. This contact is to be looped into the control circuit of the motor contactor. Therefore, the motor cannot be started during braking.</p> <p>The contact between X5 and X7 is closed during braking. Thus, it is, e.g. in the case of star-delta-connections, possible during braking to control the star contactor in order to interconnect the motor winding.</p> <p>For more detailed information, please see connection diagram under 12.1.</p>

Behavior of the changeover contact on X5, X6, X7

Status	Interlocking contact X5 – X6	Star contactor contact X5 – X7	Reset by
Motor off	closed	open	
Motor is running	closed	open	
Motor is being decelerated	open	closed	
Braking correctly finished	closed	open	
Braking frequency too high	open	closed	short disconnection from mains (5s)
Braking frequency too high by SO1 or SO3*	closed	open	not necessary
Program-controller-error	open	closed	short disconnection from mains (5s)
Braking interrupt (break on terminal X3, X4)	open	closed	closing the open contact on X3, X4

* Special device with designation suffix SO1 or SO3

9. Potentiometers

With the potentiometers it is possible to adjust the following parameters.

„I“

Adjusting the braking current.

The braking current can be adjusted in the range from approx. 10% - 100% of the rated device current. The adjustment is roughly linear.

Caution!

If braking times exceeding 20s are adjusted, the rated device current decreases according to the diagram on page 9. the rated device current indicated on the rating plate is then not reached any more.

„t“

Adapting the braking time.

The braking time can be adjusted within a range of 0 - 30 (0 - 60s in the case of SO2 and SO3**). With this potentiometer, it is possible to determine the length of time for which the braking current is to flow. During commissioning, it should be taken into account that the braking current is switched off only approx. 2s after the motor has come to a standstill. The adjustment is linear.

** Special device with designation suffix SO2 or SO3

Note! If braking times exceeding 20s are adjusted, the permissible maximum rated device current decreases. The rated device current on the label of the unit is than no more reached.

Reduction of the permissible max. braking current in the case of braking times exceeding 20 seconds for braking devices of VB ... L to 30A

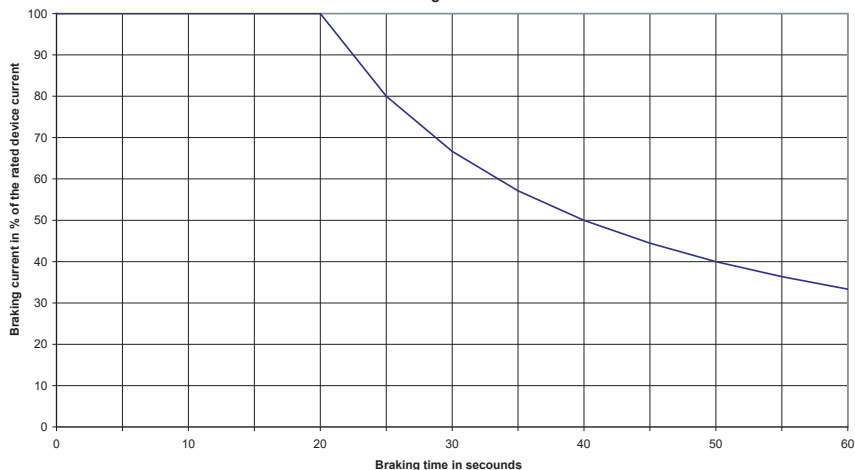

VB230/400-6/25/30LT

11

10. Technical data

Type designation	VB 230-6 LT	VB 230-25LT	VB 230-30LT	VB 400-6LT	VB 400-25 LT	VB 400-30 LT
Mains voltage according to DIN EN 50160 (IEC 38)	220/240V \pm 10% 50/60Hz			380/415V \pm 10% 50/60Hz		
Power draw of electronics	3 VA					
Recommended for rated motor currents	0.3...3A	2...12.5A	2...15A	0.3...3A	2...12.5A	2...15A
Recommended for rated motor currents on IE3 Motors	0.3...2.5A	2...9A	2...12.5A	0.3...2.5A	2...9A	2...12.5A
Rated device current	6A	25A	30A	6A	25A	30A
c.d.f. at max. braking current	60%	8%	5%	60%	8%	5%
I ² t -value of power semiconductors	310 A ² s	1250 A ² s	1350 A ² s	310 A ² s	1250 A ² s	1350 A ² s
Braking voltage	0 ... 110VDC			0 ... 220VDC		
max. Braking time	0...30s (0...60s in the case of special devices SO2 and SO3)					
Contact rating of output relays	3A/250V AC 3A/24VDC					
Delay time for reduction of residual e.m.f.	self-optimizing 0,2 ... 1,8s					
max. Cross-sectional area for connection	2 x 2,5mm ² per terminal					

10.1 Environmental conditions

Storage temperature	-25 ... 75°C
Operating temperature	0 ... 45°C
Degree of protection	IP 20
Environment	Overtoltage category III, pollution degree 2
Weight	0,6kg

Note: Please pay attention and consider for the operation of IE3 motors while dimensioning of dc brakes the resulting higher starting currents.
For the use of IE3 motors we highly recommend to dimension and design the needed braking devices one size higher.

11. Commissioning

The device is to be put into operation in 3 steps:

1. Mounting
2. Connection and
3. Parameter setting

11.1 Mounting instructions



Caution: Danger to life through electric shock!

The following conditions are to be complied with in order to ensure a safe and reliable operation of the VersiBrake...-LT:

1. The device series VersiBrake...-LT is to be used under overvoltage conditions of the category III.
2. Make sure that pollution degree 2 or better, in accordance with IEC664, is complied with.
3. The device is to be installed into a housing (min. degree of protection: IP54).
4. The device must be operated without being exposed to contamination by water, oil, carbon deposits, dust, etc..



Warning:

Make sure that a minimum distance to adjoining devices is kept. Above and underneath the housing a minimum distance of 50mm is to be kept.

11.2 Connection

The braking device is to be installed according to the attached connection diagram. For other connections please consult PETER electronic GmbH & Co. KG.

Note: Further connection proposals for special circuit arrangements are available via our homepage at www.peter-electronic.com.

Note: Prior to putting the motor brake into operation the wiring is to be checked.

To ensure reliable function is it necessary to comply with the interlocking conditions:

The interlocking contact of the braking device, terminal X5, X6, has to be looped into the control circuit of the motor contactor, in order to **prevent** the motor contactor from pulling in during braking.

11.3 Parameter settings

Sequence of steps during commissioning:

1. Disconnect the plant/system from the supply mains.
2. Adjust the requested braking current with the potentiometer „I“ (approx. 2 times the rated motor current).
Since the potentiometer reacts roughly linear, it is possible to infer the braking current from the potentiometer setting.
Left stop roughly equals 10% of the rated device current.
Mid-position roughly equals 50% of the rated device current.
Right stop equals 100% of the rated device current.
The braking current can be measured with a clamp-on ammeter (True RMS) or a corresponding moving iron amperemeter at the output terminal "4T2" of the braking device.
3. Adjust potentiometer „T“ to approx. 50% (this is equivalent to a braking time of approx. 15s /30s in the case of SO2 or SO3).
4. Switch on the plant.
5. Initiate braking by switching the motor ON/OFF.

Note: When putting the device into operation for the first time, the braking current can be checked with a true r.m.s. measuring instrument.

Adjusting the braking current

The braking current is to be adjusted so that the motor comes to a standstill within the time requested. In this connection, the braking current must not exceed 2,5 times the rated motor current.

The braking current is to be adjusted to a value as small as possible, in order to avoid unnecessary heating of the power semiconductors and motor. This is especially important in the case of high switching frequencies.

Adjusting the braking time

The time should be adjusted to a value so that the braking current still flows for 2s after the motor has come to a standstill. The optimum setting is to be determined by means of several braking operations.

Note: If 5 braking operations are triggered in direct succession, it is possible that the braking device goes into interlocked state due to overloading (i.e., the motor cannot be started, the „Ready“ LED flashes 3x). In this event, a mains reset is required and sufficient cooling time (at least 15 minutes) to be waited out.

Note: If braking times exceeding 20s are adjusted, the permissible maximum rated device current decreases. In this case, the value indicated on the rating plate is then not reached any more (see diagram on under point 7).

Note: If, after a braking operation, the „Ready“ LED flashes 2x (braking current was not reached), it may be possible that the value adjusted for the braking time was too small (0...1,5s). The braking time is then too short to build up a flow of current in the motor. If this is the case, turn potentiometer „t“ slightly clockwise.

11.4 Possible fault indications during commissioning

During commissioning, and in normal operation too, fault indications can occur. The following explanation is to give you assistance in the localization and correction of faults.

Fault indication on LED „Ready“	Fault	Possible cause	Fault correction
Flashing 2x	Adjusted braking current was not reached.	Interruption in the braking circuit. Possibly the motor is started with star-delta connection.	Check circuit. Possibly the star contactor has to be closed during braking.
		The braking time is adjusted too short. The braking current is switched off before the adjusted value is built up in the motor winding.	Adjust a slightly longer time with the potentiometer „t“ (turn slightly clockwise).
		The resistance of the motor winding is too high for the adjusted braking current	Turn braking current back so that the fault does not occur any more.

Continuance on the next page.

Continuance

Flashing 3x	Braking device is overloaded. Braking frequency is too high.	The specified max. braking frequency is exceeded.	Reduce braking current or braking frequency. During commissioning, 5 braking operations in succession can be initiated without an overload being indicated.
Flashing 4x	Program- or controller-error	Program- or main-memory of the controller is defective.	If, after several disconnections from the mains voltage, the fault is still indicated, return the device to the producer.
Malfunction without fault indication	Braking current switches off, although the motor is still rotating	Braking time adjusted too short.	Adjust a slightly higher braking time.
		Braking current adjusted to a too small value.	Adjust a slightly higher braking time.
	Motor cannot be started	After a braking interrupt, the contact on X3-X4 was not reclosed.	Make sure that the contact on X3-X4 is closed.
	When switching the mains voltage on, the pre-fuses of the braking device blow	During braking, the power section of the braking device became defective. Possibly, after a mains reset caused by overload, the recovery time of 15 min was not waited out?	Return the device to the producer. Important! Prior to installing a replacement device, it is absolutely necessary to check the contacts of the motor contactor (contact welding).
	During braking, the pre-fuses of the braking device blow	Fuse rating of pre-fuses is too low.	Select fuse/s in compliance with the dimensioning rules.
		During braking, the power section of the braking device became defective. Possibly, after a mains reset caused by overload, the recovery time of 15 min was not waited out?	Return the device to the producer. Important! Prior to installing a replacement device, it is absolutely necessary to check the contacts of the motor contactor (contact welding).
	When switching the motor on, the pre-fuses of the braking device blow	During braking, the power section of the braking device became defective. Possibly, after a mains reset caused by overload, the recovery time of 15 min was not waited out?	Return the device to the producer. Important! Prior to installing a replacement device, it is absolutely necessary to check the contacts of the motor contactor (contact welding).
Sporadic malfunction, for which there is no comprehensible explanation, may be caused by an EMC environment largely exceeding the permissible interference levels. The reason for this may be frequency inverters that are not interference-suppressed or a not optimal earthing concept.			

Note: All data sheets and commissioning instructions are available via our homepage at www.peter-electronic.com.

12. Dimensioning rules

Note! All data sheets and commissioning instructions are available on our homepage at www.peter-electronic.com.

12.1 Dimensioning of braking contactors

The braking contactor is switched on or off via a control contact of the braking device (no-load switching).

When selecting the braking contactor, it must be ensured that the contacts are able to carry the maximally occurring braking current (nominal/rated device current). Therefore, the value „conventional thermal current“ (I_{th}) is decisive when selecting the braking contactor.

If this value is not indicated, the rated operational current for AC-1-operation may be used instead.

Tip: By connecting contacts in parallel it is often possible to use a lower-priced contactor of a smaller design.

12.2 Dimensioning of pre-fuses

Basically, two types of fuse protection are available for the user.

1. Fusing according to allocation type „1“, DIN EN 60947-4-2.
After a short circuit, the braking device is allowed to be inoperative.
2. Fusing according to allocation type „2“, DIN EN 60947-4-2.
After a short circuit, the braking device must be suitable for further use. However, there is the danger that the contacts of the braking relay (braking contactor) weld. Therefore, if possible, these contacts are to be checked prior to applying again mains voltage to the device. If this check cannot be carried out by the user, the device has to be returned to the producer in order to have it checked.

The following dimensioning information refers to the below operating conditions:

- Use of standard asynchronous motors
 - Braking time not exceeding 20s, for braking devices up to 36A.
 - Braking time not exceeding 40s, for braking devices from 40A up.
 - Braking current not exceeding $2,5 \times I_{NOM}$ of the motor.
 - Cyclic duration factor (c.d.f.) not exceeding the value indicated in the data sheet.
-

Fusing according to allocation type „1“:

As pre-fuses, we recommend to use line protection fuses (utilization category gL) or automatic circuit breakers with tripping characteristic B, C, D or K.

Taking into account the maximum braking currents that occur (normally the rated device current), we recommend fuses according to table 2, column 3.

Note: Wiring cross-sectional area according to DIN VDE 0100-430, DIN EN 57100-430.

Fusing according to allocation type „2“:

The power semiconductors are to be protected by fuses of the utilization category gR (semiconductor fuses, high-speed fuses). However, since these fuses do not ensure line protection, it is necessary to use additionally line protection fuses (utilization category gL).

As for the dimensioning of the line protection fuse (gL), please refer to table 2, column 3.

To protect the semiconductors it is necessary to select gR-fuses featuring cutoff- I^2t -values of the ranges indicated in table 2, column 4. In this connection, the fuse rating of the selected fuse should not be smaller than the braking current to be expected (rated device current).

Note 1: On the basis of the recommended I^2t -value, braking current, and possibly the c.d.f., the fuse supplier is able to select a suitable type. Due to the great variety of producers, sizes, and types, PETER electronic does not recommend any particular fuses.

Note 2: If the fuse or cutoff- I^2t -value is selected too small, it may happen that the semiconductor fuse reacts during braking.

Column 1	Column 2	Column 3	Column 4
max. Braking current / Rated device current	Device type	Fuse value in the case of allocation type 1	Recommended range for cutoff- I^2t -value of semiconductor protection fuses in the case of allocation type „2“
6A	VB ...-6LT	6A	150... 250 A ² s
25A	VB ...-25LT	20A	500... 900 A ² s
30A	VB ...-30LT	25A	600... 900 A ² s

Table 2

12.3 Permissible braking frequency

The braking frequency depends on the adjusted braking current.

Please find below some typical values for braking devices of the VB...-LT type:

	Braking current	Braking time	Braking frequency
VB ...-6LT	6A	5s	1 braking operation per 8s
		10s	1 braking operation per 16s
		15s	1 braking operation per 25s
		30s	1 braking operation per 45s
VB ...-25LT	25A Rated dev. current decreases to 17A	5s	1 braking operation per 60s
		10s	1 braking operation per 120s
		15s	1 braking operation per 180s
		30s	1 braking operation per 220s
	20A Rated dev. current decreases to 17A	5s	1 braking operation per 40s
		10s	1 braking operation per 80s
		15s	1 braking operation per 120s
		30s	1 braking operation per 220s
	15A	5s	1 braking operation per 25s
		10s	1 braking operation per 50s
		15s	1 braking operation per 75s
		30s	1 braking operation per 150s
	10A	5s	1 braking operation per 17s
		10s	1 braking operation per 35s
		15s	1 braking operation per 53s
		30s	1 braking operation per 105s
VB ...-30LT	30A Rated dev. current decreases to 20A	5s	1 braking operation per 90s
		10s	1 braking operation per 180s
		15s	1 braking operation per 270s
		30s	1 braking operation per 330s
	20A	5s	1 braking operation per 40s
		10s	1 braking operation per 80s
		15s	1 braking operation per 120s
		30s	1 braking operation per 240s
	15A	5s	1 braking operation per 25s
		10s	1 braking operation per 50s
		15s	1 braking operation per 75s
		30s	1 braking operation per 150s
10A	5s	1 braking operation per 17s	
	10s	1 braking operation per 35s	
	15s	1 braking operation per 53s	
	30s	1 braking operation per 105s	

For intermediate values please refer to table 3.

Table 3

Load curve for VB 400-6 LT

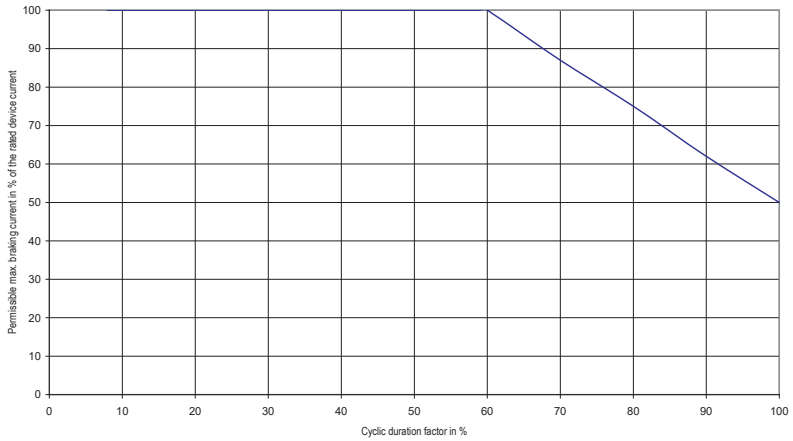

Load curve for VB ...25 LT

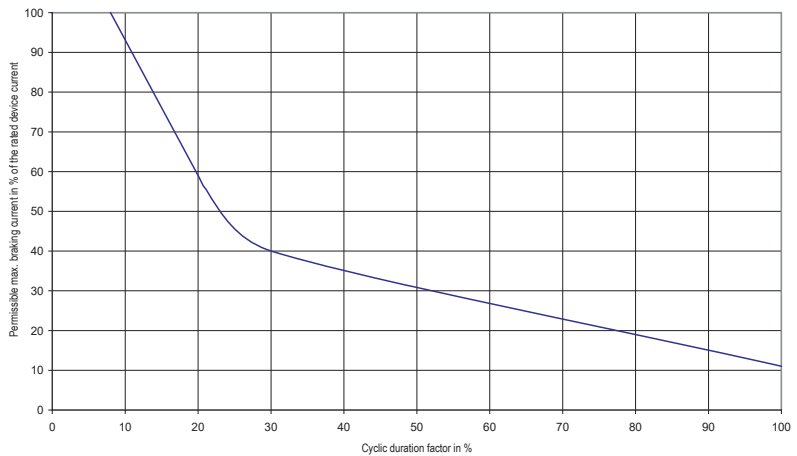

Load curve for BR 230/400-30LT

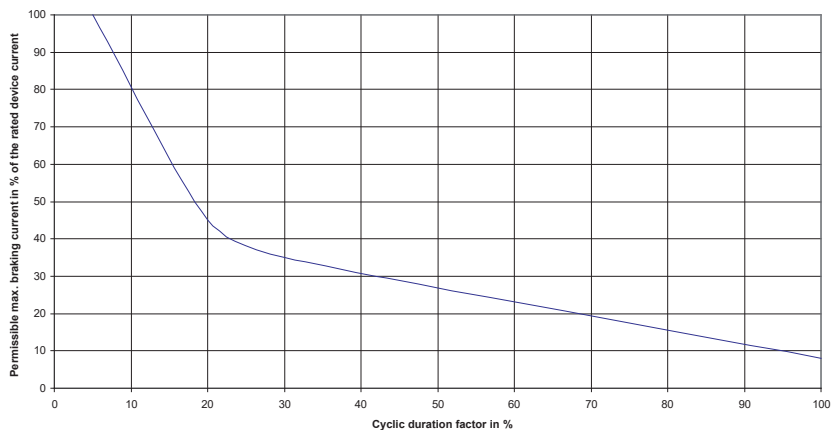

$$\text{Cyclic duration factor (r.c.d.f.)} = \frac{t_B}{\text{Cycle time}} \times 100$$

t_B = Braking time, Cycle time = Braking time + Non-braking time

13. Dimensions

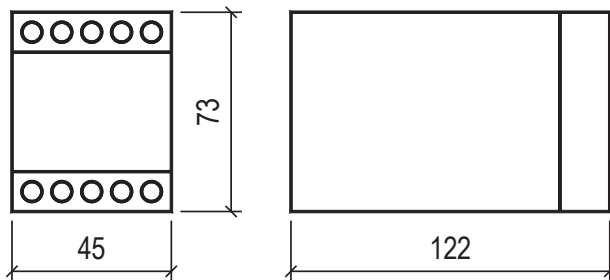

All dimensions indicated in mm.

14. Typical connections

14.1 Connection diagram

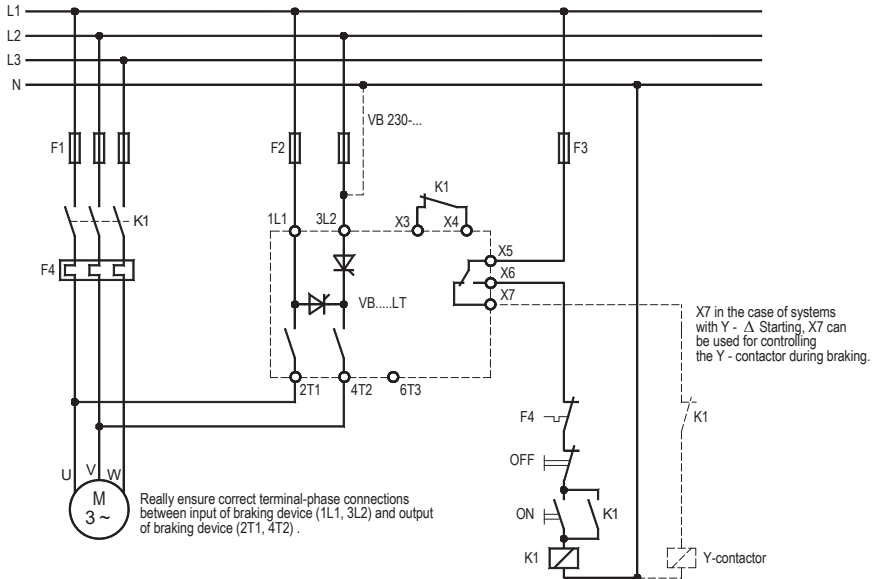

EMC

The limit values for emitted interference according to the applicable device standards do not rule out the possibility that receivers and susceptible electronic devices within a radius of 10m are subjected to interference. If such interference, which is definitely attributable to the operation of the braking devices "VB", occurs, the emitted interference can be reduced by taking appropriate measures.

Such measures are, e.g.:

To connect reactors (3mH) or a suitable mains filter in series before the braking device, or to connect X-capacitors (0,15μF) in parallel to the supply voltage terminals.



www.peter-electronic.com

