

# Absolute encoders - modular bus covers

Optical sensing, high resolution, shaft  
 Single and multiturn encoder 18 bit ST / 13 bit MT  
 CANopen / DeviceNet / EtherCAT / Profibus / SSI / fibre-optic

## GBAMW, GBMMW - *multivoPlus*



GBMMW with modular bus cover

### Features

- Encoder single- or multiturn / bus cover
- Optical sensing
- Total resolution max. 31 bit
- Clamping or synchro flange
- High resistance to shock and vibrations
- New innovative sensing technology
- Modular bus interfaces
- CANopen/DeviceNet/EtherCAT/Profibus/SSI/fibre-optic
- Code continuity check optional by bus

### Technical data - electrical ratings

Voltage supply	10...30 VDC
Reverse polarity protection	Yes
Consumption w/o load	≤100 mA (24 VDC)
Initializing time (typ.)	250 ms after power on
Interfaces	Profibus-DPV0 / V2, CANopen, DeviceNet, EtherCAT, Fibre-optic bus, SSI
User address	Rotary switch in bus cover
Steps per turn	262144 / 18 bit
Absolute accuracy	±0.01 °
Sensing method	Optical
Code	Binary
Code sequence	CW/CCW programmable
Interference immunity	DIN EN 61000-6-2
Emitted interference	DIN EN 61000-6-4
Programmable parameters	Steps per revolution Number of revolutions Preset Scaling Rotational direction
Diagnostic functions	Position or parameter error Multiturn sensing
Status indicator	DUO-LED integrated in bus cover
Approval	UL approval / E63076
<b>GBAMW</b>	
Function	Singleturn
<b>GBMMW</b>	
Function	Multiturn
Number of turns	8192 / 13 bit

### Technical data - mechanical design

Housing	ø58 mm
Shaft	ø10 mm (clamping flange) ø6 mm (synchro flange)
Flange	Clamping or synchro flange
Protection DIN EN 60529	IP 54 without shaft seal IP 65 with shaft seal
Operating speed	≤10000 rpm (mechanical) ≤6000 rpm (electric)
Starting torque	≤0.015 Nm IP 54 ≤0.03 Nm IP 65
Rotor moment of inertia	20 gcm <sup>2</sup>
Admitted shaft load	≤20 N axial ≤40 N radial
Materials	Housing: steel Flange: aluminium Bus cover: zinc die-cast or aluminium
Operating temperature	-25...+85 °C -40...+85 °C (optional)
Relative humidity	95 % non-condensing
Resistance	DIN EN 60068-2-6 Vibration 10 g, 16-2000 Hz DIN EN 60068-2-27 Shock 200 g, 6 ms
Weight approx.	600 g
Connection	Bus cover

# Absolute encoders - modular bus covers

Optical sensing, high resolution, shaft  
Single and multiturn encoder 18 bit ST / 13 bit MT  
CANopen / DeviceNet / EtherCAT / Profibus / SSI / fibre-optic

**GBAMW, GBMMW - *multivoPlus***

## Part number

### Singleturn

GBAMW.   20

	Interface
3P32	Profibus-DPV0 / cable gland
3PA2	Profibus-DPV0 / connector M12
3V32	Profibus-DPV2 / cable gland
3VA2	Profibus-DPV2 / connector M12
EPA2	EtherCAT / connector M12
5P32	CANopen / cable gland
5PA2	CANopen / connector M12
8P22	DeviceNet / cable gland
8PA2	DeviceNet / connector M12
LM32	Fibre-optic / cable gland
2PA2	SSI / connector M12

#### Flange / Shaft

- 0 Clamping flange / ø10 mm IP 54
- A Clamping flange / ø10 mm IP 65
- 1 Synchro flange / ø6 mm IP 54
- B Synchro flange / ø6 mm IP 65

CD with file descriptions is not included in the delivery. You may order them on CD as accessory free-of-charge under part number Z 150.022. Matching bus covers are listed in "Accessories".

### Multiturn

GBMMW.   20

	Interface
3P32	Profibus-DPV0 / cable gland
3PA2	Profibus-DPV0 / connector M12
3V32	Profibus-DPV2 / cable gland
3VA2	Profibus-DPV2 / connector M12
EPA2	EtherCAT / connector M12
5P32	CANopen / cable gland
5PA2	CANopen / connector M12
8P22	DeviceNet / cable gland
8PA2	DeviceNet / connector M12
LM32	Fibre-optic / cable gland
2PA2	SSI / connector M12

#### Flange / Shaft

- 0 Clamping flange / ø10 mm IP 54
- A Clamping flange / ø10 mm IP 65
- 1 Synchro flange / ø6 mm IP 54
- B Synchro flange / ø6 mm IP 65

## Accessories

### Connectors and cables

Z 119.034 Connector for data cable fibre-optic

### Mounting accessories

Z 119.006 Eccentric fixing, single

Z 119.013 Adaptor plate for clamping flange for modification into synchro flange

Z 119.015 Mounting adaptor for synchro flange

Z 119.017 Mounting angle for clamping flange

Z 119.035 Bearing flange for encoders with synchro flange

### Programming accessories

Z 150.022 CD with describing files & manuals

Z 139.008 Programming cable for encoders with SSI bus cover, CD with software and manual

# Absolute encoders - modular bus covers

Optical sensing, high resolution, shaft  
 Single and multiturn encoder 18 bit ST / 13 bit MT  
 CANopen / DeviceNet / EtherCAT / Profibus / SSI / fibre-optic

## GBAMW, GBMMW - multivoPlus

### Dimensions

#### GBAMW, GBMMW clamping flange

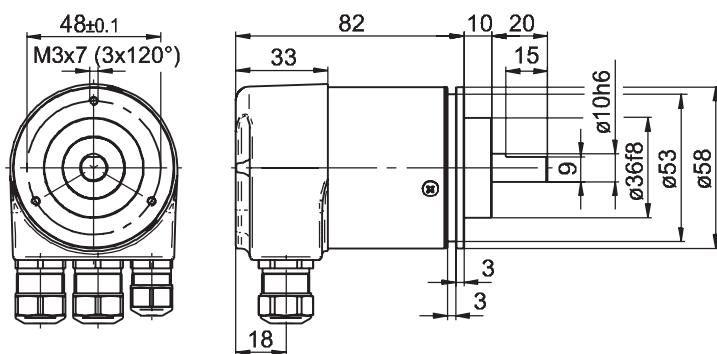

#### Profibus-DP/CANopen

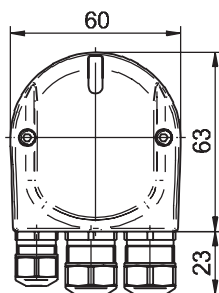

#### Profibus-DP - M12

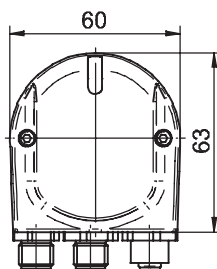

#### DeviceNet

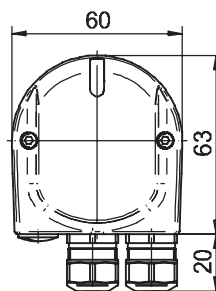

#### CANopen/DeviceNet M12

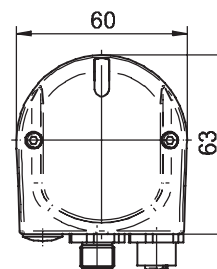

#### EtherCAT

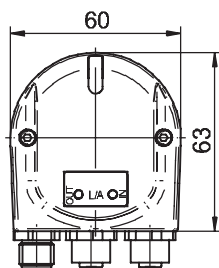

#### SSI

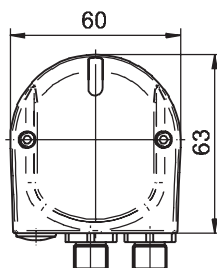

#### Fibre-optic

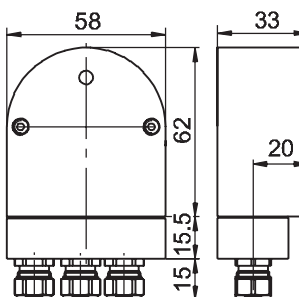

#### GBAMW, GBMMW synchro flange

